



**IMPULSE IM90i
Nc FRAMER
B30090**



ILLUSTRATED PARTS LIST

PASLODE IMPULSE IM90i Nc FRAMER B30090

Paslode
SERVICE KIT
010015

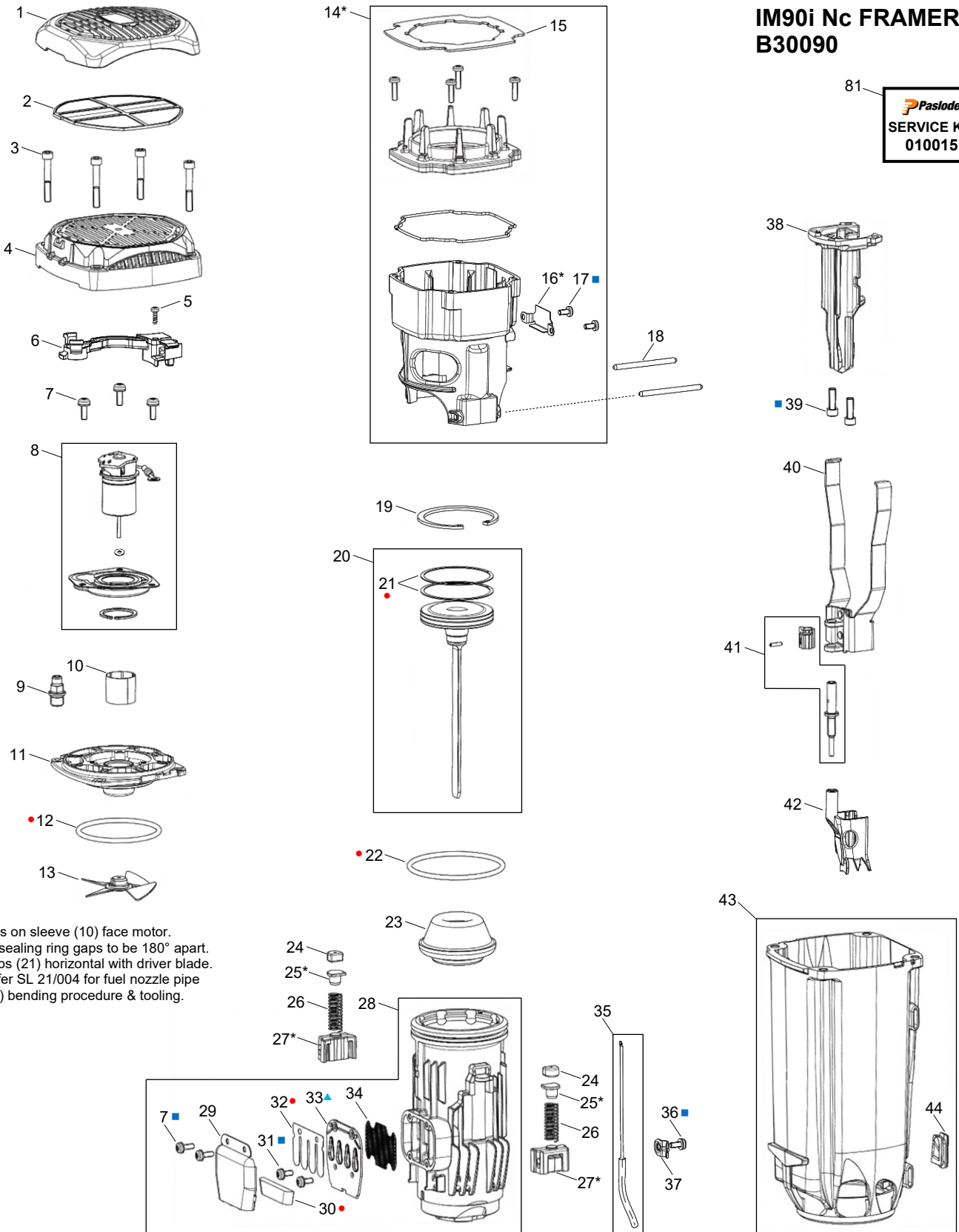

Notes:

1. Ribs on sleeve (10) face motor.
2. All sealing ring gaps to be 180° apart.
3. Refer SL 21/004 for fuel nozzle pipe (35) bending procedure & tooling.

Torque Values (in/lb)			
Item	Torque	Item	Torque
3	42-45	17	20-25
5	6-8	31	30-35
7	30-35	36	30-35
9	20-25	39	55-60
13	8-10	46	55-60

***CAUTION:**
Prior to ordering parts, determine the change status of the item(s) in the tool. Refer Change Notes for:
- Chamber Lockout items (14), (16) & (61).
- Spring & Yoke Guides (25) & (27).
Simultaneous replacement may be required.
DO NOT MIX OLD & NEW COMPONENTS

- Service Kit Item
- Loctite® 242
- ▲ Permatex® Blue

All parts sold as single items unless described as a pack, set or forms part of an assembly (multiple items defined within a box). A part with no item number is only available in an assembly.

PASLODE IMPULSE IM90i Nc FRAMER B30090

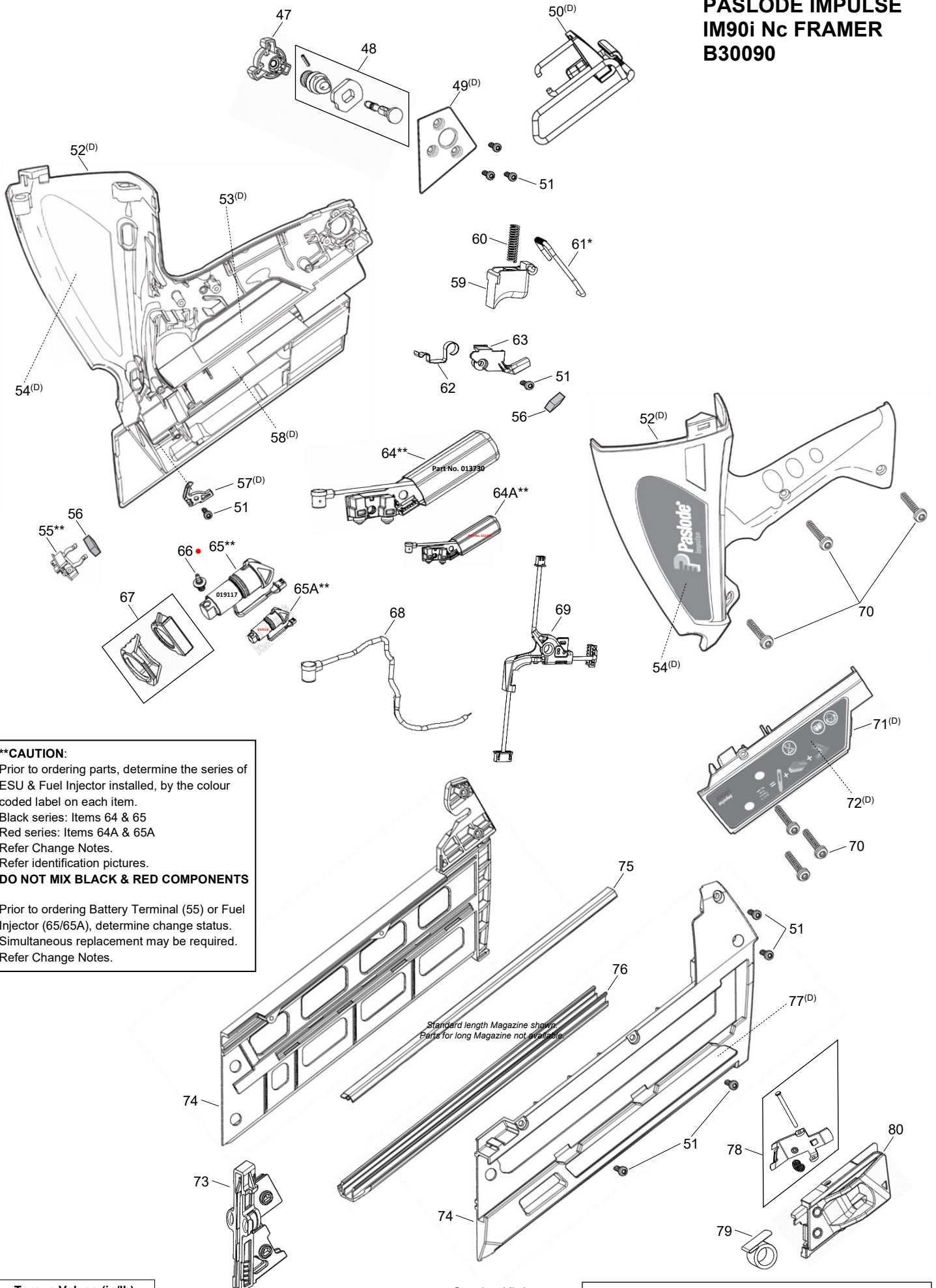

****CAUTION:**

Prior to ordering parts, determine the series of ESU & Fuel Injector installed, by the colour coded label on each item.
 Black series: Items 64 & 65
 Red series: Items 64A & 65A
 Refer Change Notes.
 Refer identification pictures.
DO NOT MIX BLACK & RED COMPONENTS

Prior to ordering Battery Terminal (55) or Fuel Injector (65/65A), determine change status.
 Simultaneous replacement may be required.
 Refer Change Notes.

Torque Values (in/lb)			
Item	Torque	Item	Torque
51	12-16	70	18-20

- Service Kit Item
- Loctite® 242

All parts sold as single items unless described as a pack, set or forms part of an assembly (multiple items defined within a box). A part with no item number is only available in an assembly.

PARTS LEGEND

PASLODE IMPULSE IM90i Nc FRAMER

B30090

1	013790	1 Grill	44	013812	1 Grommet, Housing/Fuel Line
* 2	013748	1 Filter	45	013787	1 Flange, Retaining (with nose protector)
3	013797	4 Screw SHC M5 x 35	■ 46	013813	4 Screw SHC M5 x 16
4	013770	1 Cap	47	013793	1 Knob, Magazine Release
5	404702	1 Screw PH TF 6-32 x 3/8	48	013792	1 Ball & Pin Assembly, Magazine Release
6	013808	1 Guide, Wires	→ 49		NP Cover, Release Ball (Discontinued)
■ 7	900596	5 Screw SEMS TX 8-32 x 7/16 (RPLS 405141)	→ 50		NP Belt/Rafter Hook (Discontinued)
8	013287	1 Motor Assembly, Fan (RPLS 013733)	51	013798	9 Screw TX M4 x 12
9	013731	1 Spark Plug Assembly	→ 52		NP Handle Assy (LH/RH) (Discontinued)
10	401356	1 Sleeve, Fan Motor (ALT 321590)	→ 53		NP Label, Data Plate (Discontinued)
11	013740	1 Cylinder Head	→ 54		NP Label, Logo (LH/RH) (Discontinued)
*● 12	403992	1 O-Ring, Cylinder Head (Brown) (RPLS 012012)	→ 55	013746A	1 Battery Terminal (RPLS 013746) (!Change Notes)
13	403167	1 Fan Blade Assembly (ALT 321660)	56	401450	2 Pad, Foam
→ 14	013749A	1 Combustion Chamber Assembly (RPLS 013749) (!Change Notes)	→ 57		NP Retainer, Wire (Discontinued)
15	013750	1 Air Dam	→ 58		NP Label, (IM90i) (Discontinued)
→* 16	019073	1 Wear Plate, Chamber Lock (!Change Notes)	→ 59	019119	1 Trigger (RPLS 013782)
■ 17	013805	2 Screw PH TF M4 x 8	60	013783	1 Spring, Trigger
18	013781	2 Pin, Stop	→ 61	019084	1 Lock Bar, Chamber (RPLS 013784) (!Change Notes)
19	336680	1 Circlip	62	013734	1 Lever, Switch Contact
* 20	013735	1 Driver & Piston Assembly	63	013785	1 Pivot Plate, Switch Contact Lever
*● 21	336670	2 Ring, Piston Seal	64	013730	1 Electronic Spark Unit (ESU) (Black)
*● 22	013743	1 O-Ring, Sleeve	64A	013299	1 Electronic Spark Unit (ESU) (Red)
* 23	013778	1 Bumper	→ 65	019117	1 Fuel Injector Assembly (Black) (RPLS 013771 & 013771A) (!Change Notes)
24	013758	2 Stop, Rubber	→ 65A	019116	1 Fuel Injector Assembly (Red) (RPLS 013298 & 013298A) (!Change Notes)
→ 25	019071	2 Guide, Spring (!Change Notes)	● 66	013739	1 Plug Connector, Fuel Injector/Fuel Tube
26	013779	2 Spring	67	013786	1 Ejection Button Assembly, Fuel
→ 27	019072	2 Guide, Yoke (RPLS 013780) (!Change Notes)	68	013732	1 Spark Wire Lead Assembly
28	013751	1 Sleeve Assembly	69	013289	1 Harness Assembly
29	404423	1 Cover, Muffler (ALT 336580)	70	013799	4 Screw TX M4 x 25
● 30	404422	1 Muffler (ALT 336570)	→ 71		NP Cover Assy, Handle (Discontinued)
■ 31	900595	2 Screw TX 8-32 x 3/8 (M4 x 9)	→ 72		NP Label, Cover (Discontinued)
● 32	404424	1 Reed Valve (ALT 336560)	73	013741	1 Shear Block
33	404425	1 Reed Plate	74	013759	1 Magazine Halves (LH/RH) (Standard)
34	404426	1 Baffle, Exhaust	75	013763	1 Channel, Nail (Standard)
35	013737	1 Pipe & Tube Assembly, Fuel Injection	76	013764	1 Cover Plate, Magazine (Standard)
→■ 36	900595	1 Screw SEMS TX 8-32 x 3/8 (RPLS 405140)	→ 77		NP Label, Reload (Std) (Discontinued)
37	013738	1 Bracket, Fuel Line	78	013762	1 Pusher/Button Assembly, Follower
38	013757	1 Nose	79	013767	1 Spring, Negator
■ 39	013796	2 Screw SHC M5 x 16	80	013761	1 Follower
40	013744	1 Yoke	81	010015	AR Service Kit
41	013742	1 Knob Assy, Depth of Drive Adjustment			
42	019074	1 Probe (RPLS 013745)			
43	013769	1 Housing			

* Normal Wear Items

● Included in Service Kit

■ Apply Loctite® 242 (Blue)

▲ Apply Permatex® Ultra-Blue Gasket Sealant 81724

→ New Change

NP Non Procurable

AR As Required

Remove battery & brads before commencing service.



Use eye and ear protection when operating/testing tools.

Use eye protection when cleaning tools.

Use degreaser in a well ventilated area.



WARNING: All parts must be periodically inspected and replaced if worn or damaged. Failure to comply can affect the tool's operation and present a safety hazard.

ACCESSORIES

Battery

Part No. B30150



Battery Charger system
(Australia/New Zealand)



Battery Charger Kit (Shown)
Transformer

Part No. 013200A
(RPLS B30200)
Part No. B20544C

Carry Case



Standard magazine

Part No. 014977*
(Substitute for 013200)

Long magazine

Part No. 013226
(Discontinued)

*Substitute case 014977 has minor interference with Belt/Rafter Hook

No Mar Probe Assembly
Rubber tipped probe to eliminate marring work surface



Replacement Tip Kit
(includes 2 tips, bracket, screw & nut + spanner)

Part No. 013211
(RPLS B30300)
Part No. 013256

Long Magazine

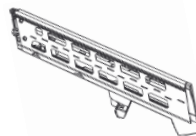

Part No. 013225
(RPLS B30250, SP30250)

4mm Hex Key

For servicing and clearing jams.



Part No. 401331

T7 Torx Key

For Fan grub screw



Part No. 900183

Paslode Impulse Lubricating Oil

Specially formulated for use in Paslode® Impulse tools.



Part No. B20544F

Impulse Tool Cleaner/Degreaser

Recommended cleaner for all Paslode®



Part No. B20544L



Change Notes

Revision 0

Item	Part No.	Item Description	Change	Action/Change Description
8*	404425	Reed Plate	Availability	Non-procurable (made procurable per R2 item 90*)
9*	404426	Exhaust Baffle		Non-procurable (made procurable per R2 item 91*)
32*	-	Bush		POA ¹ 4, Cap 013770 (Note only, never procurable)
54*	-	LH Handle		Handles issued as an assembly (RH/LH 53*/52, discontinued per R3)

¹ Purchase on Assembly

*Item numbering per previous revision

Revision 1

Item	Part No.	Item Description	Change	Action/Change Description
36*	013733	Fan Motor	Availability	Replaced by 013287, Fan Motor Assembly
41*	013747	Wire Harness	Enhancement	Replaced by 013289

*Item numbering per previous revision

Revision 2

Item	Part No.	Item Description	Change	Action/Change Description
10*	336560	Reed Valve	Format	Replaced by 404424
11*	336580	Muffler Cover		Replaced by 404423
12*	405141	Screw TX 8-32 x 7/16 (M4 x 11)	Design	Replaced by 900596 (SEMS)
13*	405140	Screw TX 8-32 x 3/8 (M4 x 9)		Replaced by 900595 (SEMS)
14*	336570	Muffler	Format	Replaced by 404422
21*	900456	Screw TX M4 x 15	Manufacturing	Replaced by 900969 (Non procurable per R3)
38*	321610	Retaining Ring (Curved)	Format	Replaced by 401355 (Non procurable per R3)
39*	334310	Fan Motor Mount		Replaced by 900470 (Non procurable per R3)
40*	321590	Fan Motor Sleeve		Replaced by 401356
41*	013747	Wire Harness	Manufacturing	Replaced by 013289
43*	012012	Cylinder Head O-Ring		Replaced by 403992
44*	321660	Fan Blade Assembly	Format	Replaced by 403167
85*	013231	Maintenance Kit	Availability	Discontinued
89*	013789	Belt Hook	Enhancement	Replaced by 013255 (Non procurable per R3) (Previously used item number 47*)
90*	404425	Reed Plate	Availability	Made procurable (Previously used item numbers 8* & 9* respectively)
91*	404426	Exhaust Baffle		

*Item numbering per previous revision





Revision 3



Item	Part No.	Item Description	Change	Action/Change Description
21*	900969	Screw TX M4-15	Availability	POA ¹ 14, Combustion Chamber Assy 013749
29*	013791	Cap Label		Discontinued
38*	321610	Retaining Ring (ALT 321610)		POA 8, Fan Motor Assembly 013287
39*	334310	Fan Motor Mount (ALT 334310)		
71*	013765	Magazine Cover Plate (Long)		Discontinued
75*	013801	Label, Magazine (Long)		
76*	013760	Magazine (LH/RH) (Long)		
78*	013766	Nail Channel (Long)		
14	013749	Combustion Chamber Assy	Enhancement	Combustion Chamber Assy replaced by 013749A Chamber Lock Wear Plate replaced by 019073 Chamber Lock Bar replaced by 019084 All parts must be replaced simultaneously.
16	N/A	Chamber Lock Wear Plate		
61	013784	Chamber Lock Bar		
25	019071	Spring Guide		Spring Guide introduced Yoke Guide replaced by 019072
27	013780	Yoke Guide		When replacing Yoke Guide (27), new Spring Guide (25) must be installed.
42	013745	Probe	Design	Replaced by 019074
49	013788	Cover, Release Ball	Availability	Discontinued
50	013255	Belt/Rafter Hook (RPLS 013789)		
52	013768	Handle Assembly (LH/RH)		
53	013775	Label, Data Plate		
54	013772	Label, Logo (LH/RH)		
55	013746	Battery Terminal	Enhancement	Replaced by 013746A. Simultaneous replacement of Fuel Injector (65/65A), may be required. AU/NZ PNs vary. Refer Change Notes.
57	013811	Wire Retainer	Availability	Discontinued
58	013773	Label, IM90i (RH Handel)	Design	Replaced by 019119 (change to suit IM90Ci)
65	013771	Fuel Injector Assembly (Black)	Enhancement	Replaced by 013771A (Superseded)
	013771A			Replaced by 019117
65A	013298	Fuel Injector Assembly (Red)		Replaced by 013298A (Superseded)
	013298A			Replaced by 019116
71	013776	Handle Cover Assembly		Availability
72	013777	Label, Cover		
77	013794	Label, Mag Reload (Std)		
Acc	B20544H	Car Adaptor	Availability	
	B30225	Charger Base		
	013226	Carry Case, Long Magazine		Non-procurable
	013224	Long Magazine		
N/A	Various	Assemblies/Flag Notes	Schematic	Complete layout re-design & re-numbering for clarity Added tool re-assembly notes Added cautionary notes Defined available ANZ assemblies Added flags for discontinued parts Added Service Kit & Kit item flags Added Loctite® flags
		Parts/Notes	Parts Legend	Updated PN availability & re-numbered Added alternate EU PNs (advisory only) Added Service Kit & Kit item flags Updated Loctite® and item usage Adopted conventional naming
		Accessories	Accessories	Defined available ANZ Accessories - Updated part numbers - Added No Mar replacement tip kit PN - Added T7 Torx Key reference - Added 4mm Hex Key reference - Updated Carry Case details - Removed non-procurable items



¹ Purchase on Assembly

*Item numbering per previous revision

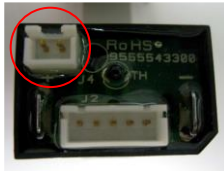
Change Notes

Chamber Lockout					
Note new entry angle of 0° on Chamber lip (14) & Wear Plate (16). Note new Lock Bar (61) with spring roller.					
If either of the old parts listed below require replacement, all old parts must be replaced simultaneously.					
Item	Description	Old PN	Old Identification	New PN	New Identification
14	Combustion Chamber	013749		019073	
16	Wear Plate	N/A		019073	
61	Lock Bar	013784		019084	

Battery Terminal circuitry & Fuel Injector Connector					
Note new Battery Terminal circuitry is resin filled.					
Note new Battery Terminal circuitry has new a JST type socket to accept new Fuel Injector connector (circled).					
Note new JST connector on Fuel Injector.					
No PN change for new parts sold in NZ. New parts in AU identified for sale with an 'A' suffix e.g. 013746A.					
PN 013771(A) (black) subsequently replaced by 019117. PN 013298(A) (red) subsequently replaced by 019116.					
If either of the old parts listed below require replacement, all old parts must be replaced simultaneously.					
Item	Description	Old PN	Old Identification	New PN	New Identification
55	Battery Connection	013746		013746(A)	
65	Fuel Injector Assembly (Black)	013771 with standard connector		013771(A) with JST connector or 019117	
65A	Fuel Injector Assembly (Red)	013298 with standard connector		013298(A) with JST connector or 019116	

Yoke Guide and Spring Guide					
New Spring Guide (25) must installed when replacing old Yoke Guide (013780) new Yoke Guide (019072).					
Note flat side of Spring Guide (25) faces the sleeve.					
Item	Description	Old PN	Old Identification	New PN	New Identification
25	Spring Guide	N/A		019071	
27	Yoke Guide	013780		019072	

ESU Identification

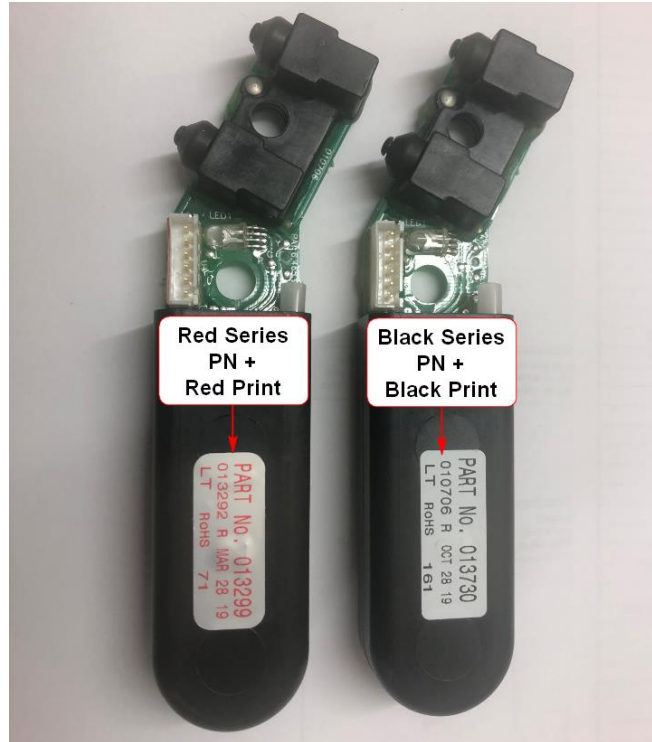

Fuel Injector Identification

